

Specification sheet

XB 120

FA 4X2 Rigid, 12t Electric

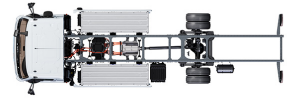

ENGINES

XB Electric 12t PACCAR EX-M1 (120 kW / 141 kWh | 210/282 kWh)

GVM¹⁾

12000 kg

Max. front 4480 kg

Max. rear 8480 kg

GCM²⁾

12000 kg

CAB EXTERIOR

Day Cab with steel bumper, tinted glass and electric window openers. Main mirrors and wide angle mirrors electrically heated. Cab width 2130 mm.; Electrically adjustable mirrors; Mirror brackets, body 2.50-2.60 m; Front view mirror; Rear view camera.

Optional

02576 Extended Day Cab	07343 Kerb view window co-driver door
03175 Cab suspension rubber and mechanical	00915 Side no glass / rear single glass
01605 Cab suspension mechanical reinforced	09101 Green tinted glass, heated
09983 Fog lights	03605 Mirror brackets, body 2.10-2.29 m
09984 Fog lights and cornering lights	09282 Mirror brackets, body 2.30-2.40 m
06629 Two hazard beacon lights	09283 Mirror brackets, body 2.40-2.50 m
02083 Two hazard beacon lights LED	

AERODYNAMICS

Optional

09286 Roof air deflector prepared	07092 Adjustable roof air deflector low (set)
06776 Adjustable roof air deflector	09287 Side collars prepared
07109 Adjustable roof air deflector high (set)	07112 Side collars long (set)

COLOURS

; Head lamp panel and bumper: Stone Grey; Cab steps and wing Stone Grey; Chassis colour grey..

Optional

06485 Head lamp panel and bumper: cab colour	16153 Cab and chassis colours
01109 Cab steps and wing in cab colour	

CAB INTERIOR

Left-hand drive (LHD); Mechanically adjustable steering column; Driver seat: air suspended; Co-driver seat: fixed velour; Storage box on engine tunnel.

Optional

01847 Right-hand drive (RHD)	16158 Seat types
09271 Steering wheel, leather, colour black	04246 Roof hatch, manual control
03516 Pneumatically adjustable steering column	04258 Roof hatch, electric control
00967 Seat belts red	

COMMUNICATION AND DRIVING MANAGEMENT

FMS connector, prepared; Tachograph digital, Stoneridge 1C version G2V2; Driver Performance Assistant.

Optional

16155 Audio equipment, makes and types

SAFETY AND SECURITY

Speed limit recognition; DAF drowsiness detection; Drive-off Assist.

Optional

08631 Air bag (driver) and 2 seat belt tensioners	01723 No reverse warning
07414 Reverse warning with self-adjusting volume	

SUSPENSION AND AXLES

Front axle type 45N. Parabolic leaf suspension with shock absorbers and stabiliser. Max. load 4.5 tonnes.; Single reduction driven rear axle type SR8.14 with parabolic leaf suspension, including shock absorbers and stabiliser. Max. load 8.50 tonnes..

Optional

00988 Rear: 8.50 t, air suspension, SR8.14	01372 Rear springs air
---	-------------------------------

WHEELS AND TYRES

Front axle(s): 245/70R17.5; Driven rear axle(s): 245/70R17.5; Goodyear; Wheel protection rings silvergrey.

Optional

06764 Wheel protection rings black	16152 Tyre makes and types
---	-----------------------------------

DRIVELINE

Electric motor type EX-M1; 120 kW; Battery Electric Vehicle; Rear axle ratio 4.88.

BRAKE SYSTEM

Optional

09524 Park brake control with spoken warning

CHASSIS

Wheelbase 4.65 m / rear overhang 2.75 m; Side member height 210 mm; Battery box LH rear, no spare wheel carrier; Battery pack H-type; 1 HV battery pack: L1, H-type; 1 HV battery pack; Spray suppression.

Optional

00566 Battery box LH rear, spare wheel carrier rear	01696 2 HV battery packs
00585 Battery box LH rear, spare wheel carrier RH	01623 Rear underrun protection
04181 Battery pack C-type	02011 Spare wheel carrier in rear overhang
00703 1 HV battery pack: R1, H-type	07071 Spare wheel carrier right-hand side
00684 2 HV battery packs: L1+ R1, C-type	03323 Rear light with LEDs
00686 2 HV battery packs: L1+ R1, H-type	

DRAWBAR AND TRAILER EQUIPMENT

Closing member D-value = 0kN.

BODIES AND PREPARATIONS FOR BODYING

Standard body attachment hole pattern.

Optional

01502 No side marker lights

24V POWER SUPPLY

Batteries 2x 125 Ah..

Optional

01257 Batteries 2x140Ah	08797 Batteries 2x175Ah
--------------------------------	--------------------------------

GVM AND GCM

Chassis weight related technical GVM max 12000 kg; Driveline related technical GCM equal to GVM.

APPLICATION CONDITIONS

Optional

01282 Moderate climate

VEHICLE DELIVERY

Standard toolkit.

Optional

06491 Toolkit Eastern Europe

Go to [DAF.com](https://www.daf.com) to configure your own perfect DAF.

XB 120

FA 4X2 Rigid, 12t Electric

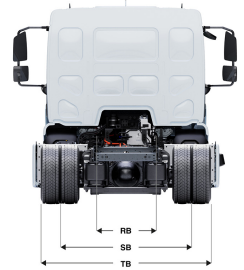
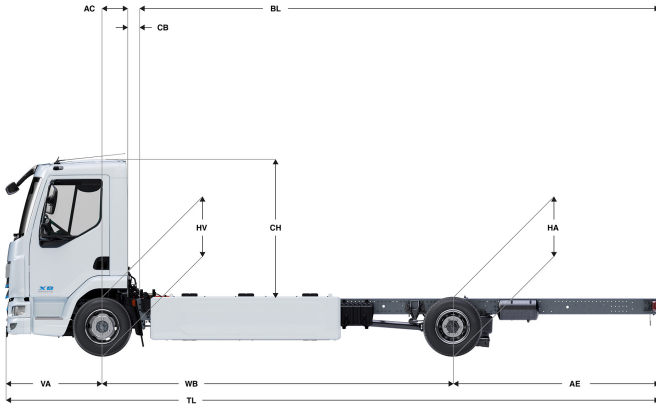

	Wheelbase - AE		Unladen weight ¹⁾			Gross Carrying Capacity			Variable dimensions									
	WB	AE ⁵⁾	Front	Rear	Total	Front	Rear	Total	AC	CB ⁶⁾	CH ⁷⁾	BL ⁸⁾	BL	TL	HA ⁹⁾	HA ¹⁰⁾	TK ¹¹⁾	TW ¹²⁾
DAY CAB	4,30	2,43	2151	1175	3326	2329	7305	8674	0,33	0,21	1,87	5,19	6,17	8,02	0,95	0,91	13,55	14,92
	4,65	2,75	2142	1138	3279	2338	7342	8721	0,33	0,21	1,87	5,71	6,77	8,69	0,98	0,87	14,41	15,79
	5,00	2,83	2154	1157	3311	2326	7323	8689	0,33	0,21	1,87	6,23	7,37	9,12	0,98	0,88	15,27	16,67
	5,40	2,43	2182	1144	3326	2298	7336	8674	0,33	0,21	1,87	6,84	8,07	9,12	0,98	0,90	16,26	17,66
	5,70	2,41	2190	1146	3337	2290	7334	8663	0,33	0,21	1,87	7,29	8,59	9,40	0,98	0,91	17,00	18,41

OTHER DIMENSIONS VA: 1,29 HV¹³⁾: 0,94 HV¹⁴⁾: 0,88 RB: 0,86 SB: 1,75 TB¹⁵⁾: 2,33

1) GVM in conformity with registration documents.
 2) GCM in conformity with registration documents.
 3) Axle load with standard tyre size.
 4) Chassis and cab weight calculated with: Standard specification items only with 0 litres of fuel, 0 litres of AdBlue® and driver of 0 kg, tolerance ± 3%. Changing of the specification can have major impact on vehicle weight.
 5) Other AE dimensions may be available for shown WB. Modify rear overhang to the calculated body length.
 6) CB is based on standard air intake and/or exhaust.
 7) Cab height is measured from frame member to closed cabin roof hatch.

8) Calculate customer specific body length with TOPEC. Body lengths shown based on evenly distributed load at max axle load.
 9) Unladen height at centre of driven axle(s).
 10) Laden height at centre of driven axle(s).
 11) TK = turning circle between kerbs.
 12) TW = turning circle between walls.
 13) Unladen height at centre of front axle(s).
 14) Laden height at centre of front axle(s).
 15) TB is overall width at rear. (At centre of front axle 255).

Depending on the vehicle configuration a specific option may not be possible. The availability and specification of this vehicle may differ per country. For further information please contact the DAF organisation. Pictures and technical illustrations are not binding in detail and can differ from the standard specification. Subject to modification without prior notice.